

Assembly Tips and Tricks

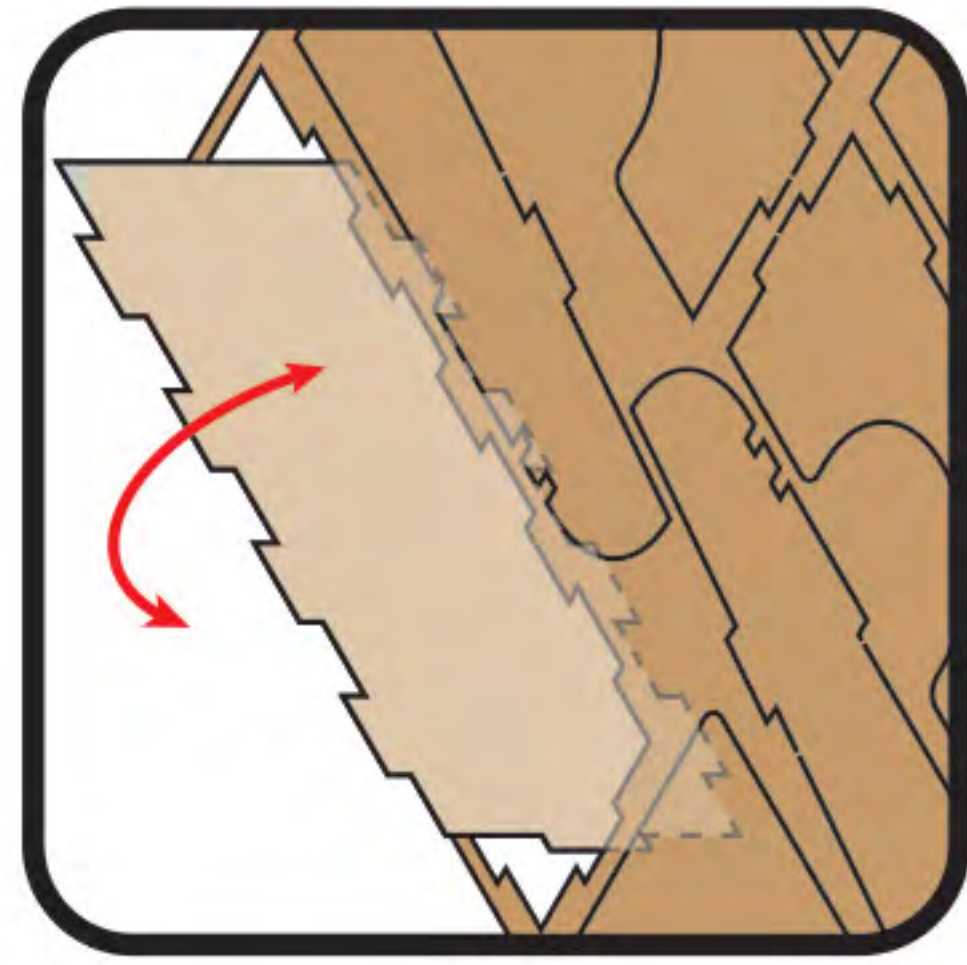

Remove parts from the frame by rotating them back and forth until they break free.



Trim off any excess wood with a hobby knife.

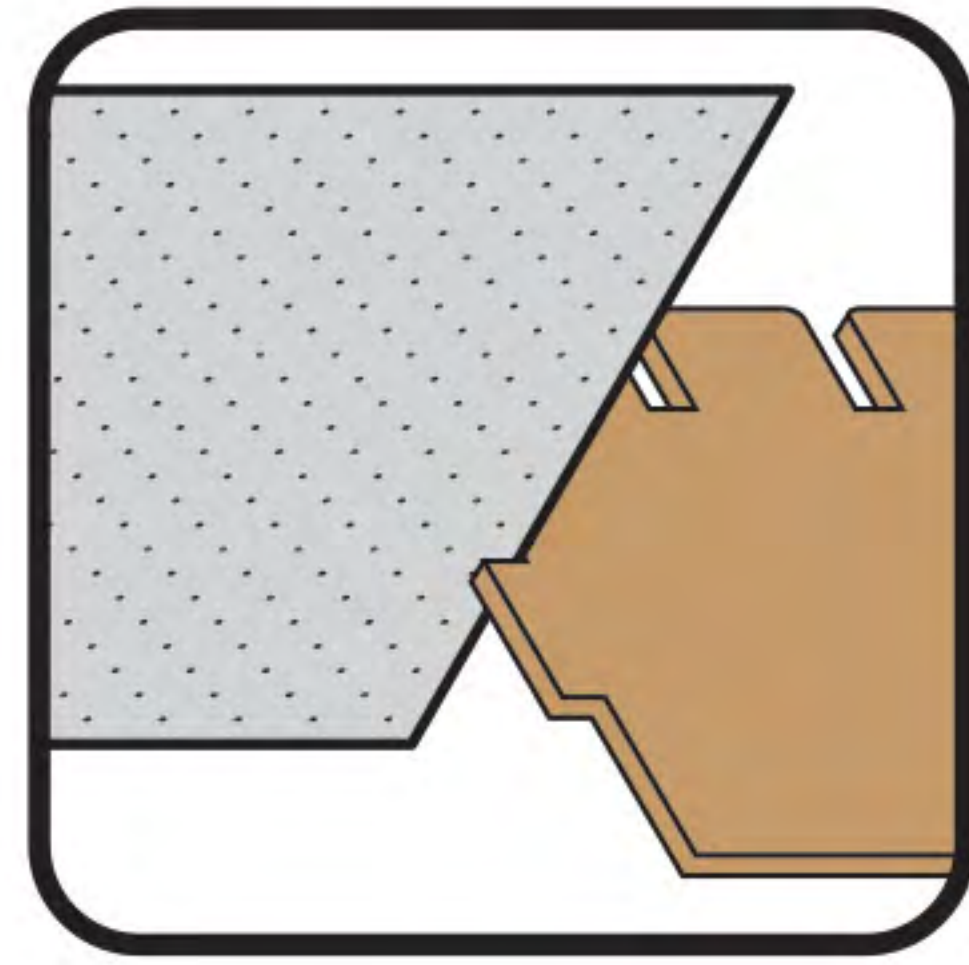

Tight pieces can be sanded, or trimmed with a hobby knife, to create a better fit.



Loose pieces may be assembled with a small amount of wood glue.

We recommend using glue for any removable trays or parts that are handled frequently.

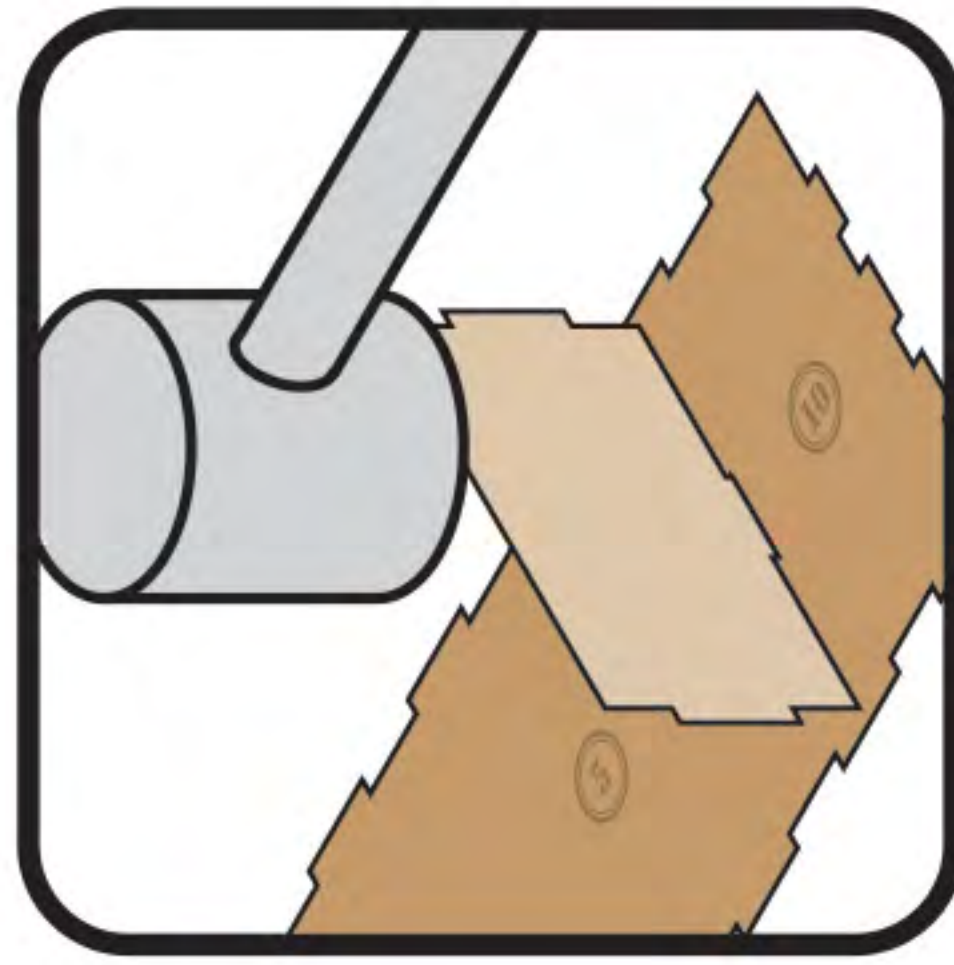

Gently tap pieces together with a mallet, hammer or other blunt object.

See more assembly tips and product videos on YouTube: [youtube.com/thebroken-token](https://www.youtube.com/thebroken-token) or contact us via through our website: www.thebroken-token.com/contact-us

You Might Also Be Interested in...

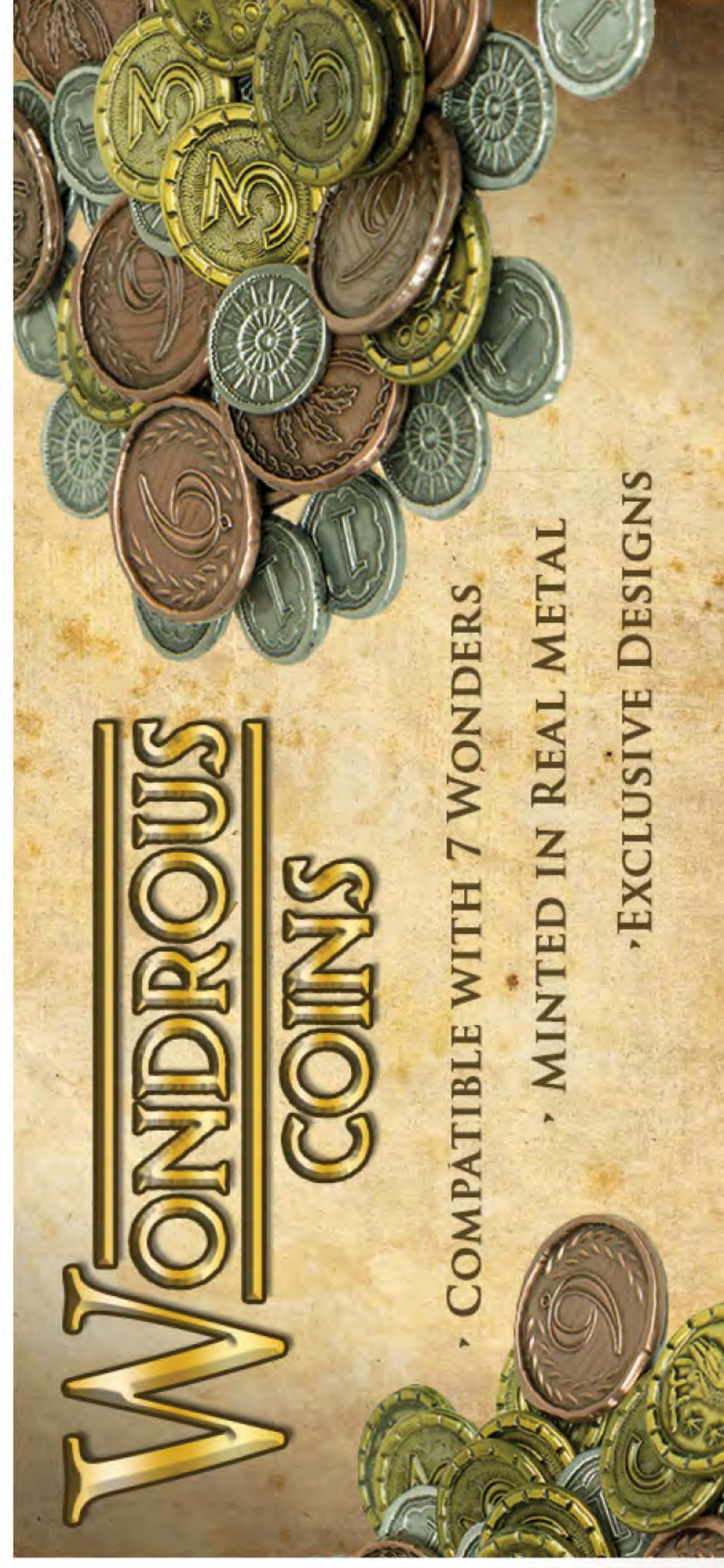

@tbt_gaming

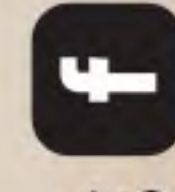

thebroken-token



thebroken-token



thebroken-token

www.thebroken-token.com

www.thebroken-token.com

WONDROUS ORGANIZER

compatible with
7 Wonders™



This box organizer is compatible with 7 Wonders™ and its expansions. This is a non-licensed product and all trademarks and copyrights are properties of their respective owners.

Product subject to change without notice. ©2015 The Broken Token, LLC. Visit thebroken-token.com for our full line of gaming organizers and accessories.



Warning: Not a toy. Not suitable for children under 14 years of age. Usage under parental guidance or guidance of adults only.

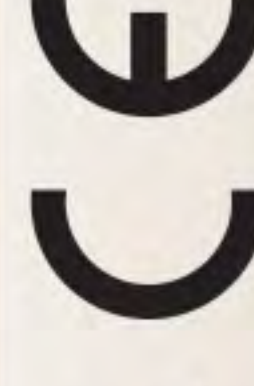

ORG003



0 19372 41711 8

Assembly Instructions

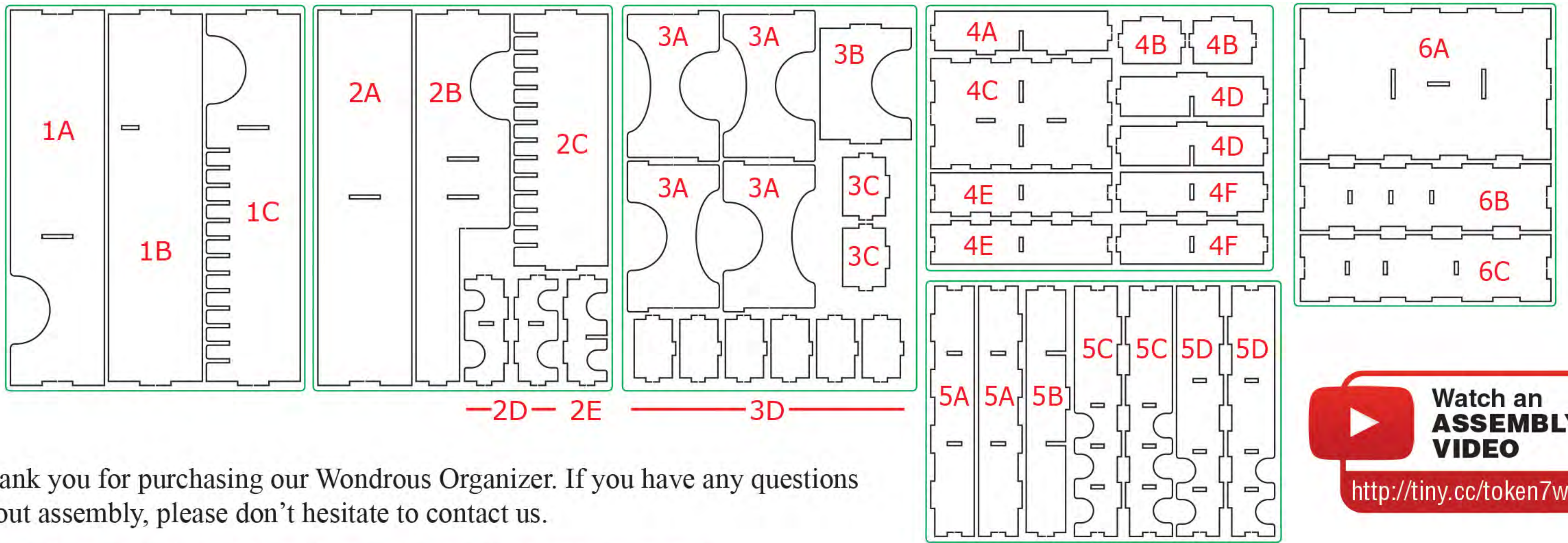

Thank you for purchasing our Wondrous Organizer. If you have any questions about assembly, please don't hesitate to contact us.

Note: Glue should be used on all joints. Wood glue is recommended.

Main Box Assembly

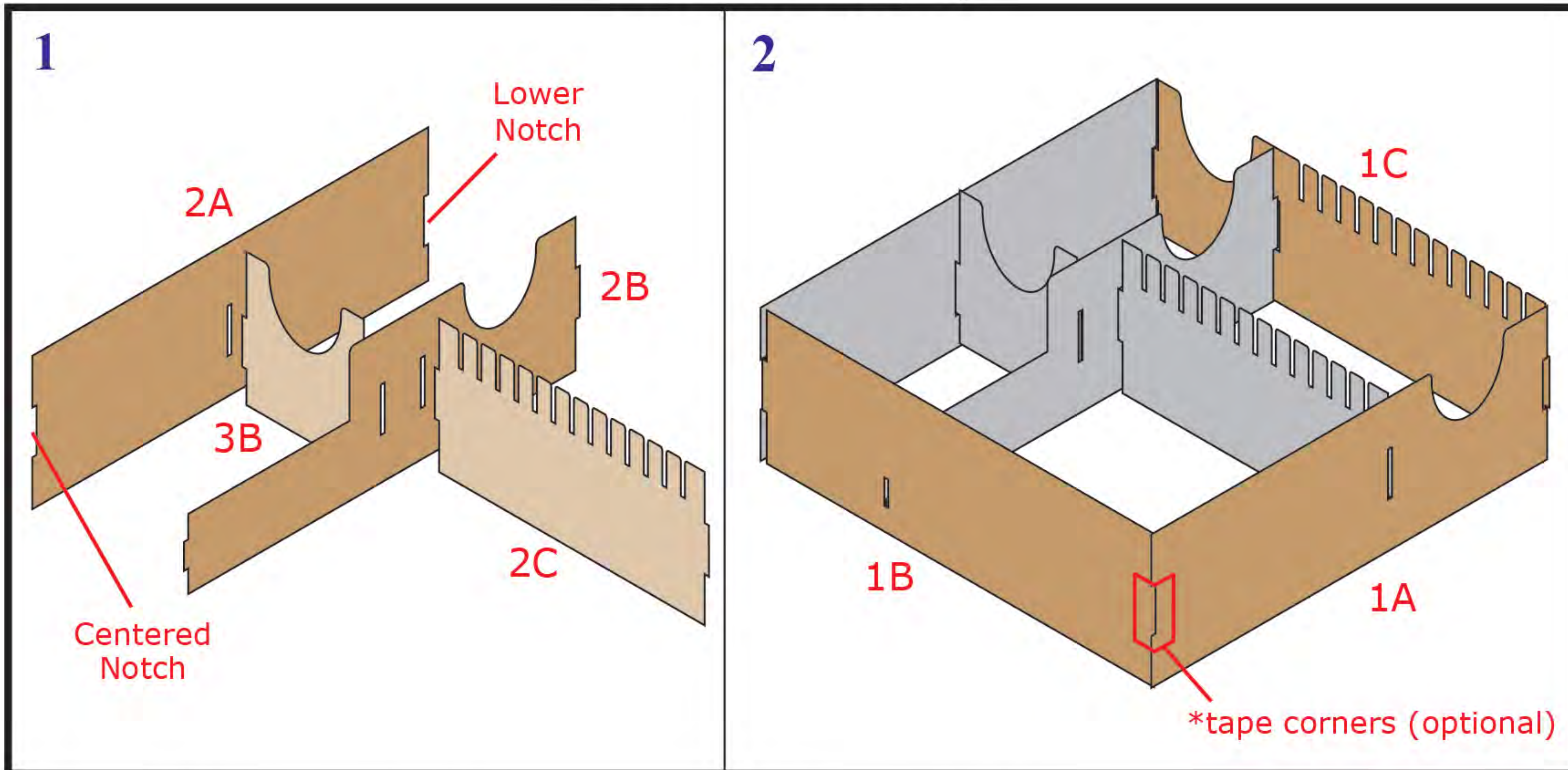

Tray C Assembly

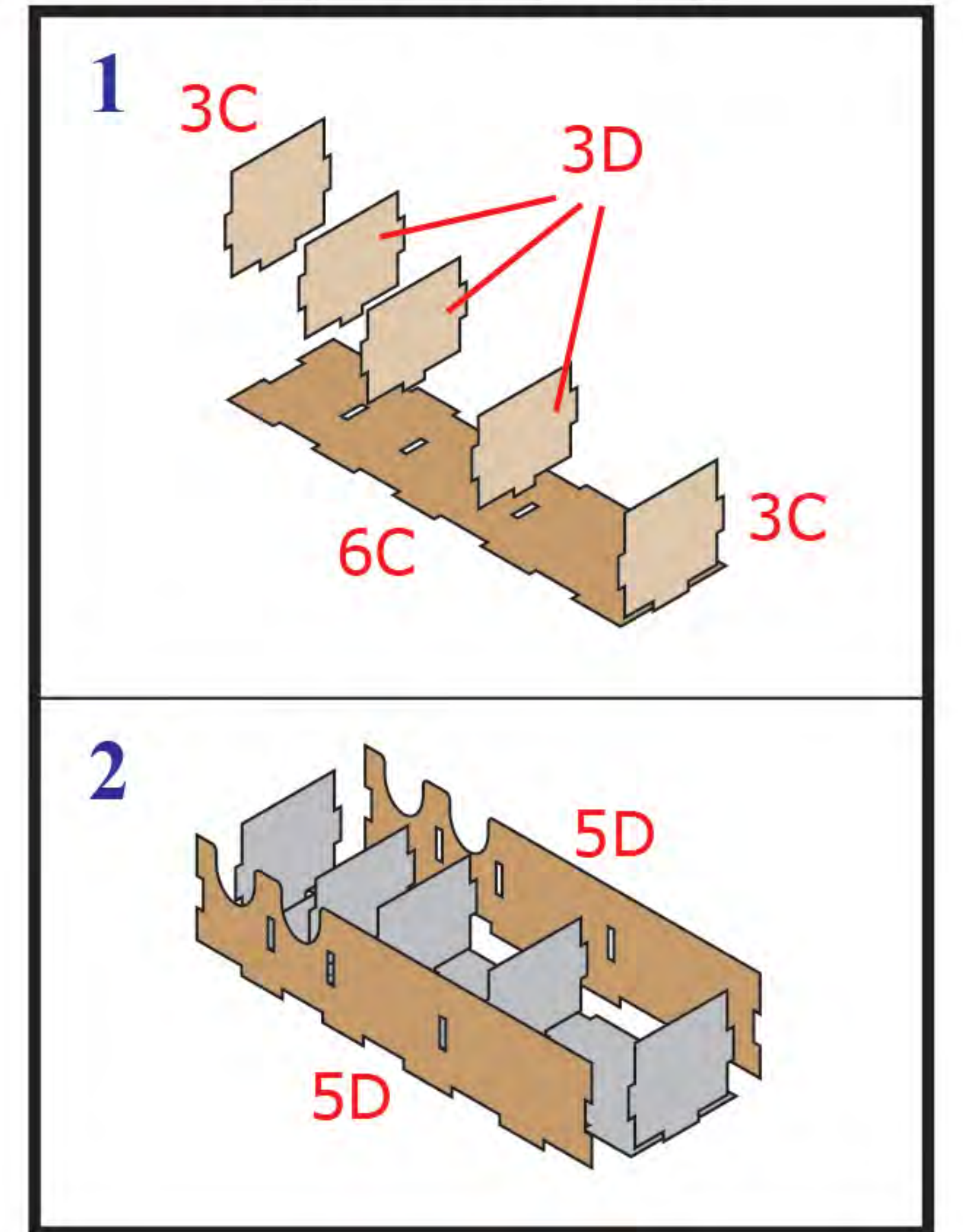

Tray D Assembly

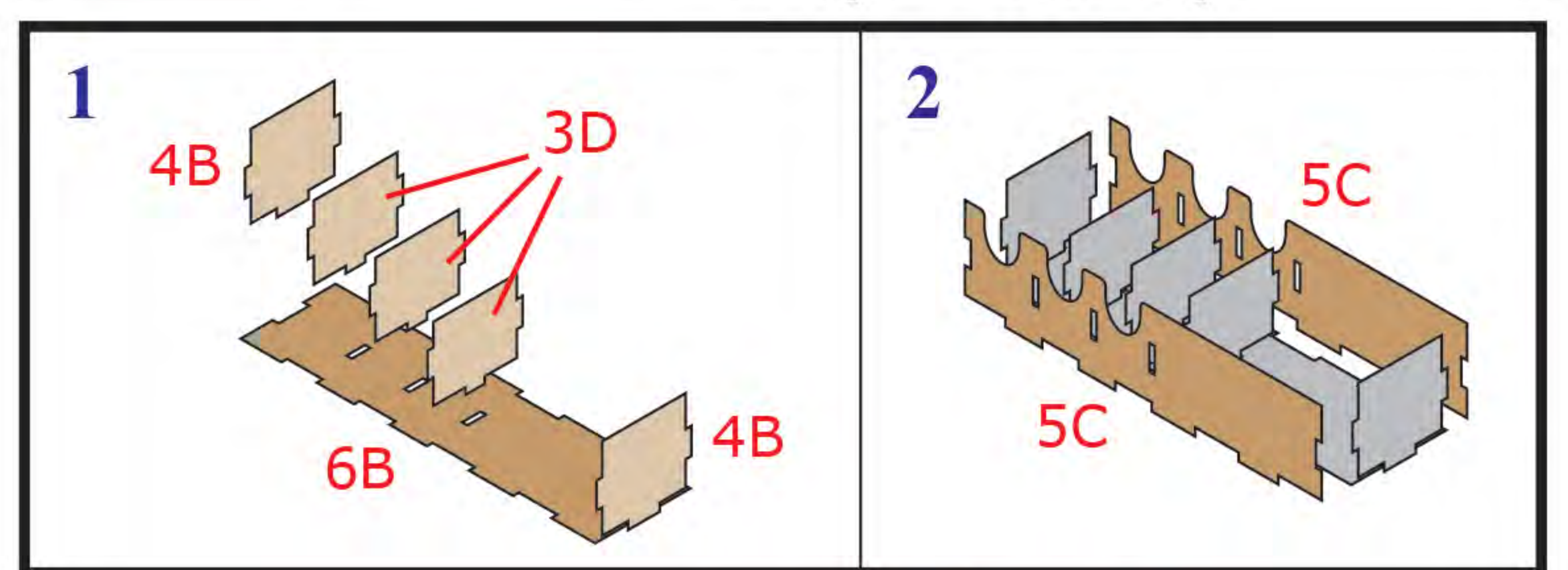

Tray A Assembly

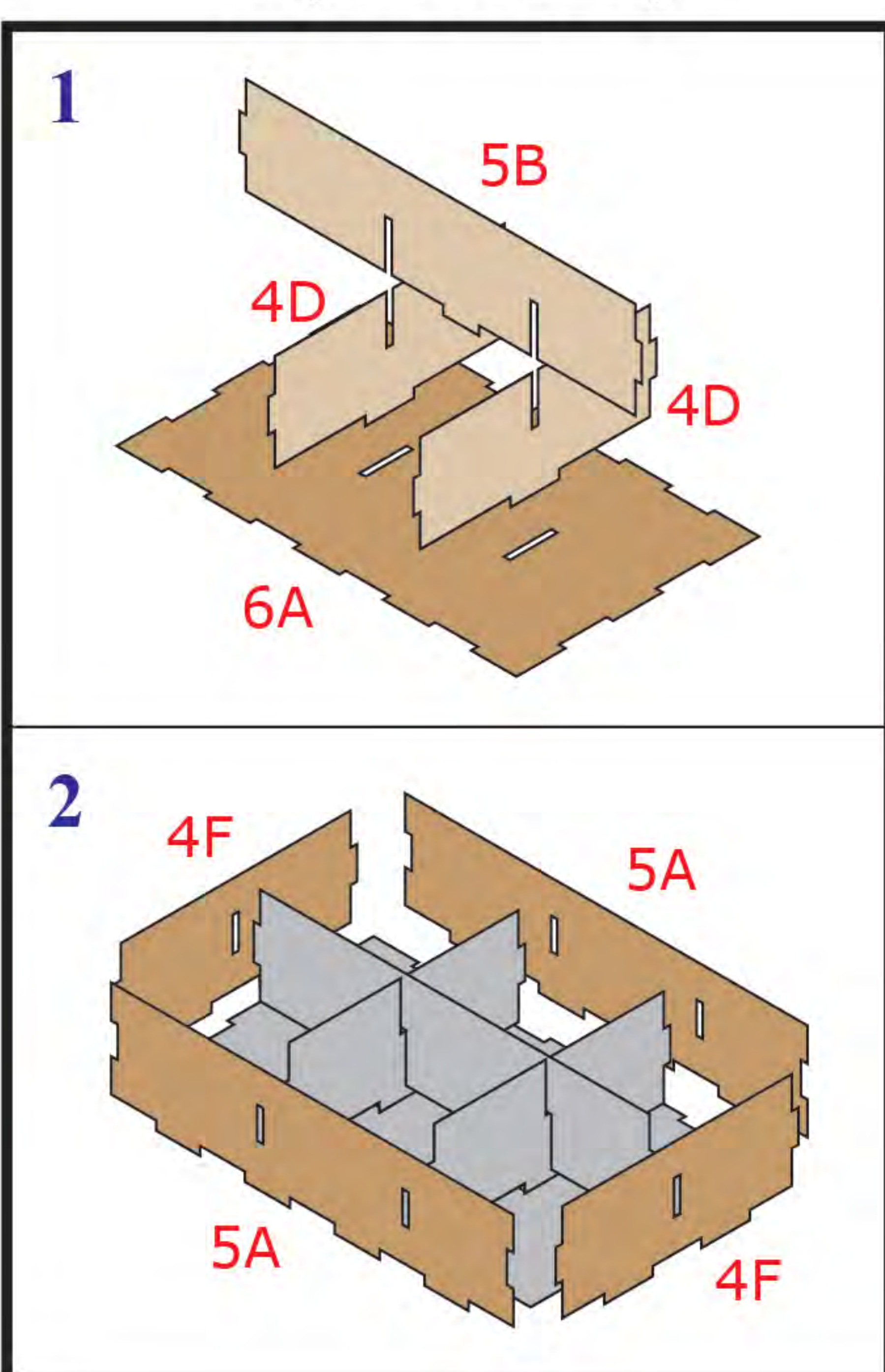

Tray B Assembly

