

Assembly Tips and Tricks

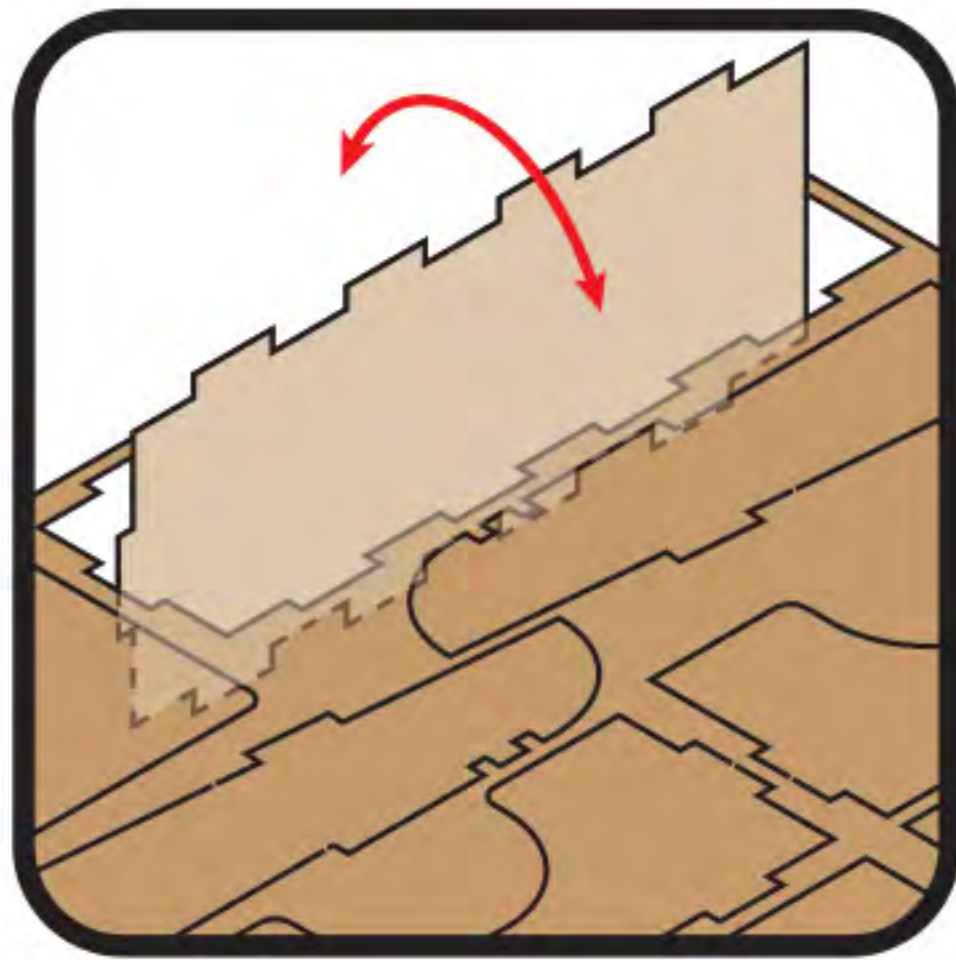

Remove parts from the frame by rotating them back and forth until they break free.

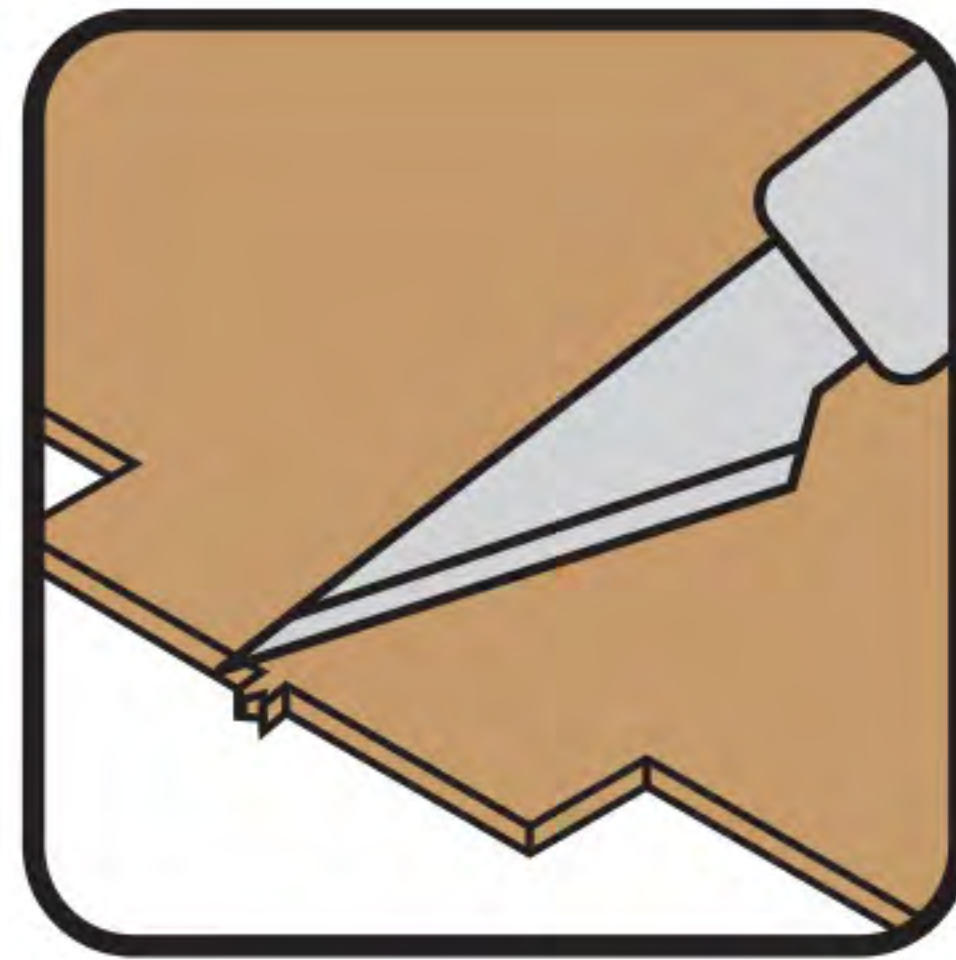

Trim off any excess wood with a hobby knife.

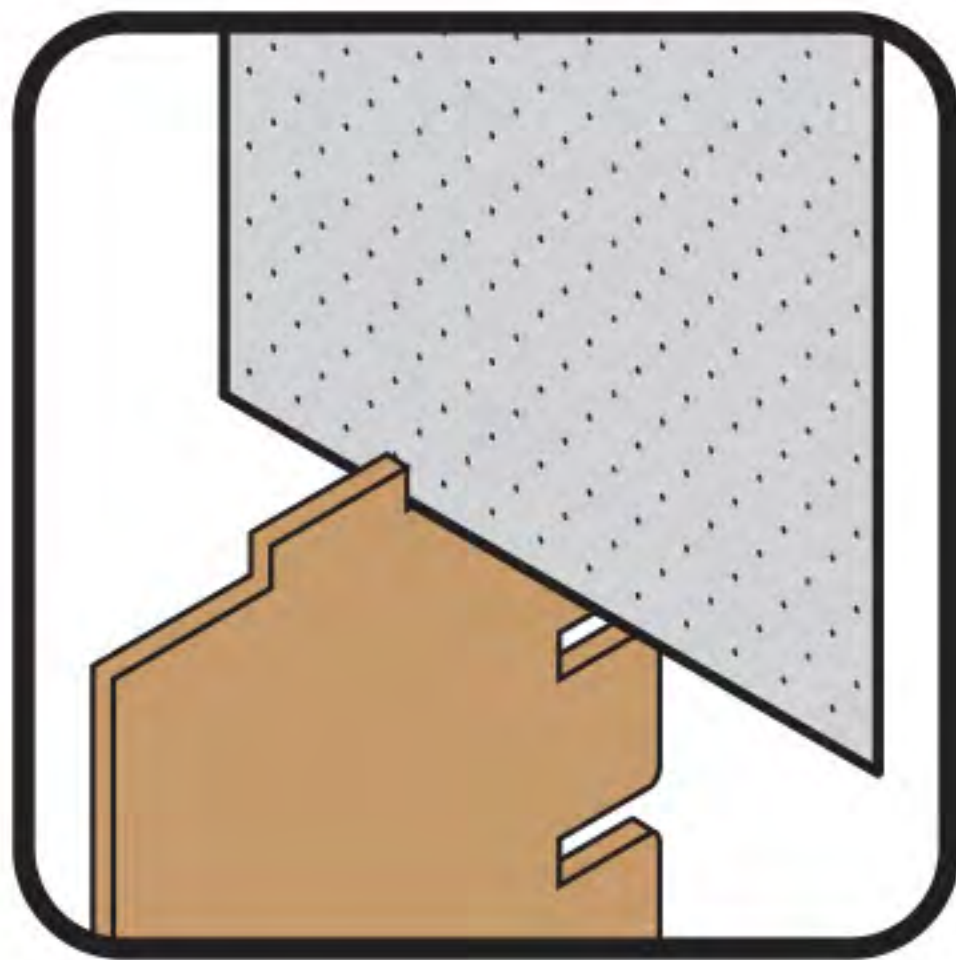

Tight pieces can be sanded, or trimmed with a hobby knife, to create a better fit.



Loose pieces may be assembled with a small amount of wood glue.

We recommend using glue for any removable trays or parts that are handled frequently.

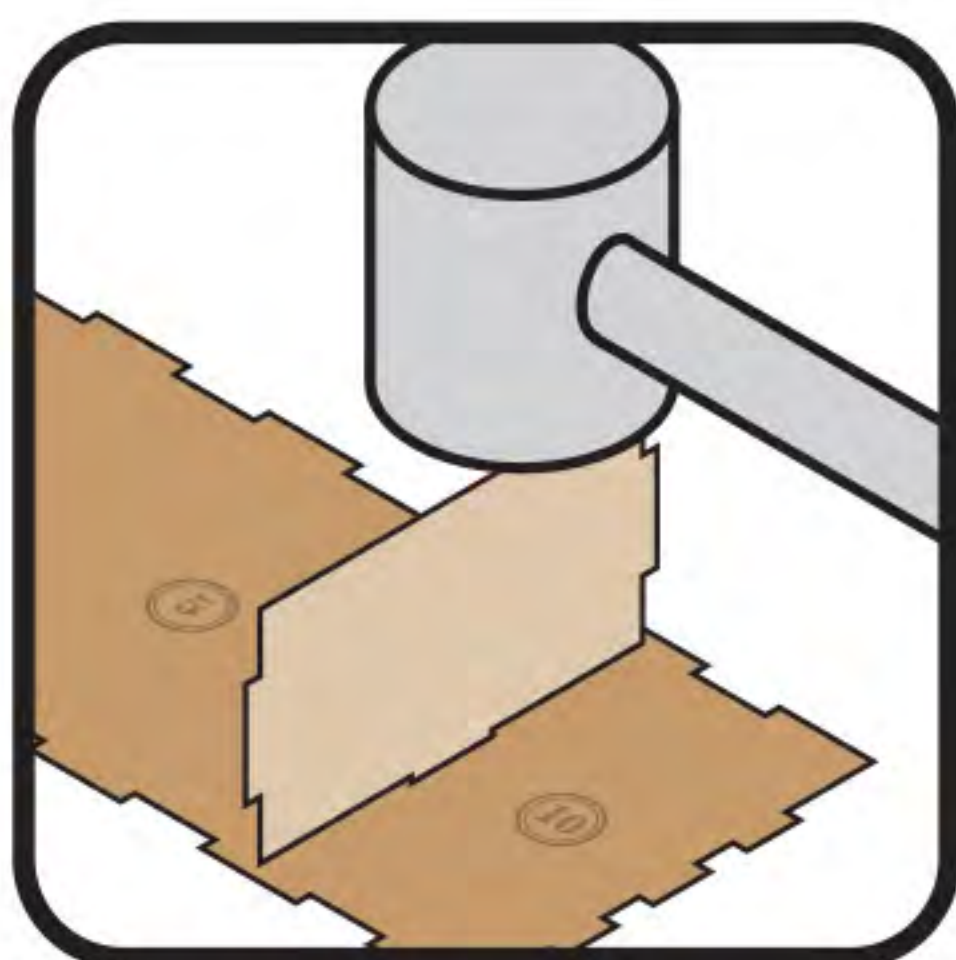

Gently tap pieces together with a mallet, hammer or other blunt object.

See more assembly tips and product videos on YouTube: [youtube.com/thebrokentoken](https://www.youtube.com/thebrokentoken) or contact us via through our website: www.thebrokentoken.com/contact-us



www.thebrokentoken.com

GALACTIC CORE ORGANIZER

compatible with
Core Worlds



Organizer is designed to fit in the Galactic Orders expansion box.

ORG018



This box organizer is compatible with Core Worlds and is a non-licensed product. All trademarks and copyrights are properties of their respective owners.

Product subject to change without notice. ©2016 The Broken Token, LLC. Visit thebrokentoken.com for our full line of gaming organizers and accessories.



Warning: Not a toy. Not suitable for children under 14 years of age. Usage under parental guidance or guidance of adults only.



www.thebrokentoken.com

@tbt_gaming thebrokentoken thebrokentoken thebrokentoken

Assembly Instructions

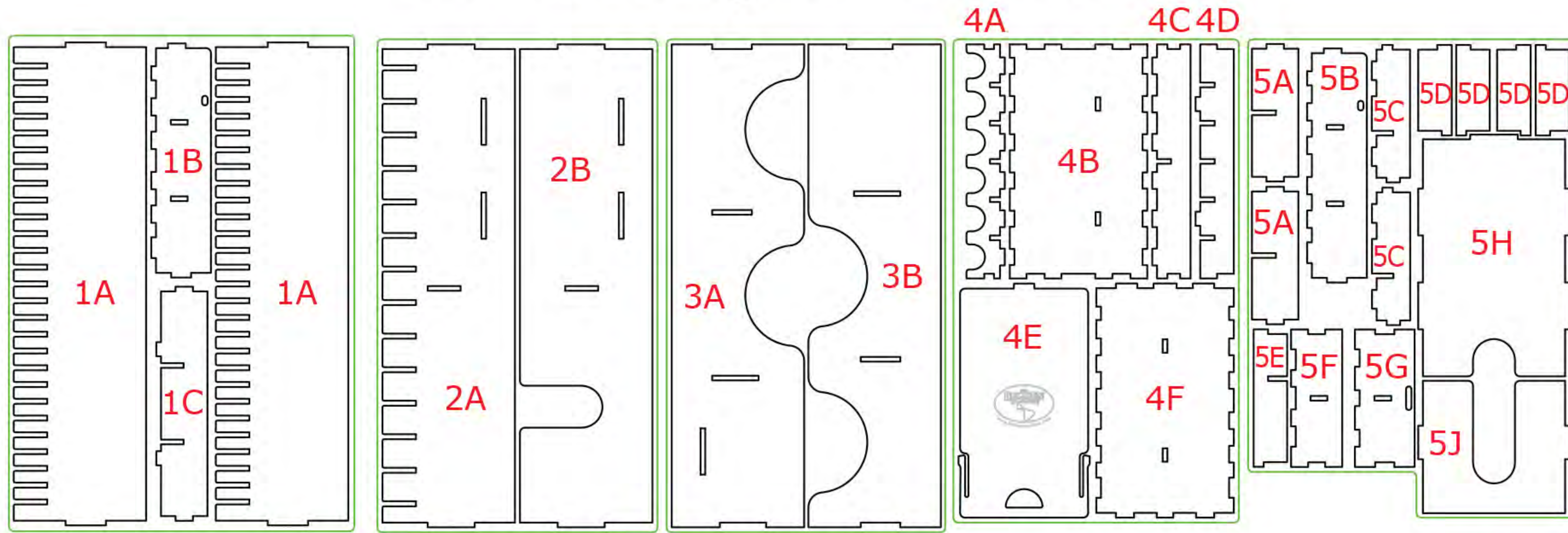

Thank you for purchasing our Galactic Core Organizer. If you have any questions about assembly, please don't hesitate to contact us.

Note: Glue should be used on loose joints. Wood glue is recommended.



Main Box Assembly

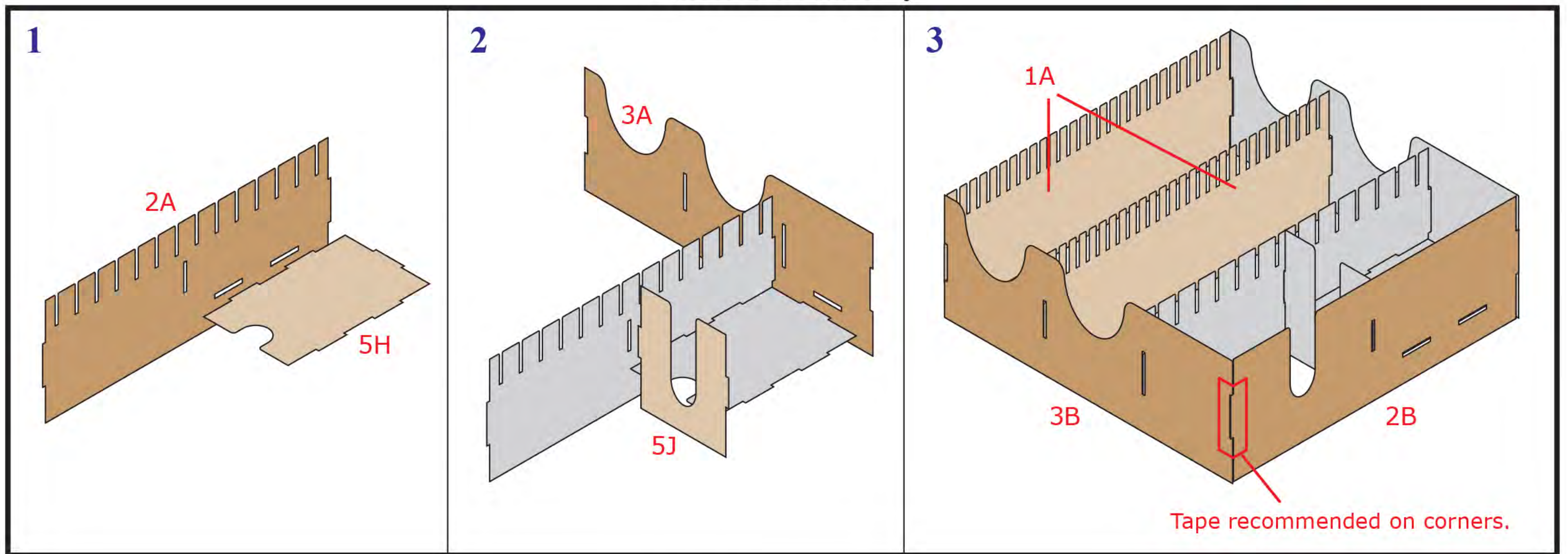

Top Tray Assembly

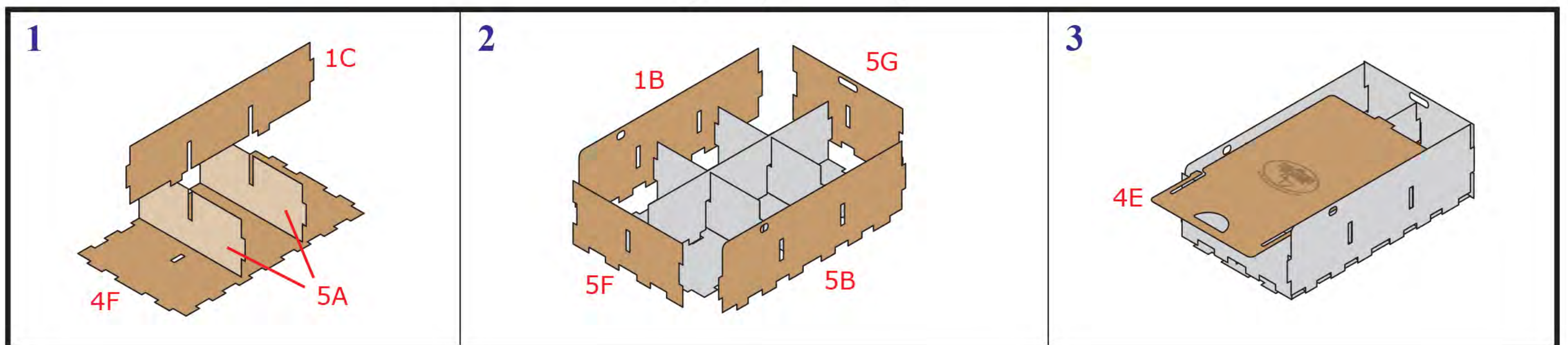

Bottom Tray Assembly

